

CHAPTER 6A

INTEGRITY IMPACT ROUND TOPS

Table of Contents

	PAGE
History	6A.2
Part Identification – Casement	6A.3
Part Identification – Double Hung	6A.4
Parts	
Miscellaneous	6A.5
Wood Parts	6A.6
Round Top Grilles and Fastener	6A.8
Glass Replacement Shapes	6A.9
RT 1 and RT 2 – Casement and Double Hung One Lite	6A.11
RT 6 – Casement and Double Hung One Lite	6A.12
RT 7 and RT 8 – Casement and Double Hung One Lite	6A.13
RT 27 – One Lite	6A.13

ATTENTION:

- Specification and technical data are subject to change without notice.
- Numbers listed in parentheses () are metric equivalents in millimeters rounded to the nearest whole number.

PRODUCED	UNIT TYPE	FEATURES OR CHANGES	DISCONTINUED
April 2014	Impact Round Top	Introduced a Glass Reinforced composite Round Top window for the IZ3/Impact product line. Available in CA and DH / DR frame types. A fiberglass reinforced composite construction, utilizing existing wood frame interior. Units have a standard jamb depth of 4 9/16". With offerings of 6 9/16" and 6 13/16".	Present

**IMPACT ROUND TOP
CASEMENT**

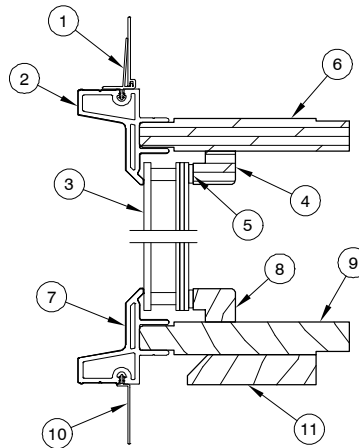

**HEAD JAMB
& SILL DETAIL**

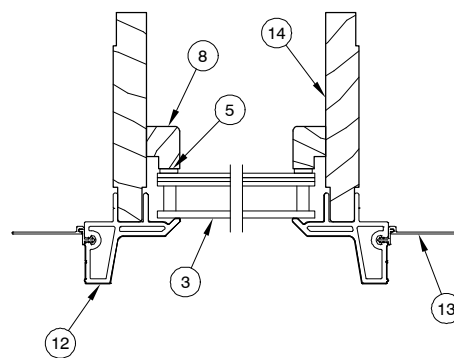

**JAMB
DETAIL**

NOTE: Not to scale; specifications subject to change without notice.

- 1. Radius Nailing Fin
- 2. Head Jamb Cladding
- 3. Insulating Glass
- 4. Glazing Bead (Radiused)
- 5. Glazing Tape
- 6. Head Jamb

- 7. Sill Cladding
- 8. Glazing Bead
- 9. Sill
- 10. Sill Nailing Fin
- 11. Sill Standing Block
- 12. Jamb Cladding

- 13. Jamb Nailing Fin
- 14. Jamb

**IMPACT ROUND TOP
DOUBLE HUNG**

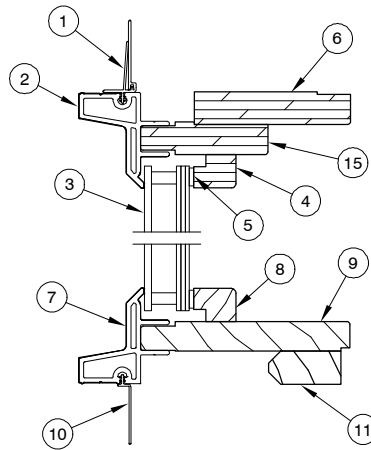

**HEAD JAMB
& SILL DETAIL**

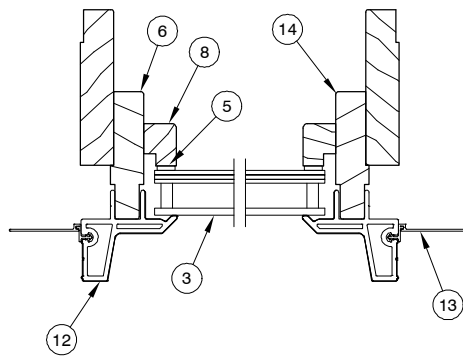

**JAMB
DETAIL**

NOTE: Not to scale; specifications subject to change without notice.

- | | | |
|----------------------------|-------------------------|-------------------------|
| 1. Radius Nailing Fin | 6. Secondary Bent Frame | 11. Sill Standing Block |
| 2. Head Jamb Cladding | 7. Sill Cladding | 12. Jamb Cladding |
| 3. Insulating Glass | 8. Glazing Bead | 13. Jamb Nailing Fin |
| 4. Glazing Bead (Radiused) | 9. Sill | 14. Primary Bent Frame |
| 5. Glazing Tape | 10. Sill Nailing Fin | |

When ordering replacement parts specify:

1. Description;
2. Length;
3. Part number.

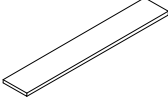
ILLUSTRATION <i>NOT TO SCALE</i>	DESCRIPTION	LENGTH	PART NUMBER
	Glazing Tape <i>NOTE: 2-sided adhesive foam tape</i> 3/32" x 3/8"	100' (30.48 meters)	11406236

When ordering replacement wood parts specify:

1. Profile number;
2. Description;
3. Part number;
4. Bare wood or white interior.

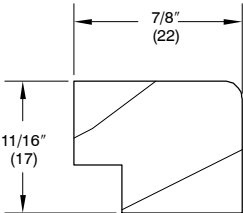
ILLUSTRATION NOT TO SCALE	DESCRIPTION	CALL NUMBER	BARE WOOD	WHITE INTERIOR
<p>Replacement Stops</p> 	<p>IRT IZ3 CA W10161- Complete set</p> <p style="text-align: right;">RT1 RT1 RT1 RT1 RT1 RT1 RT1 RT1 RT1 RT2 RT2 RT2 RT6 RT6 RT6 RT7 & RT8 RT7 & RT8</p>	<p style="text-align: center;">29-1W 33-1W 37-1W 21-2W 25-2W 29-2W 33-2W 37-2W / 25-3W 37W 49W 73W 37W 49W / 57W 65W / 73W IQCIRM - 25 IQCIRM - 29</p>	<p style="text-align: center;">39208254 39208256 39208258 39208260 39208262 39208264 39208266 29208268 39208270 39208271 39208273 39208274 39208276 39208277 39208279 39208280</p>	<p style="text-align: center;">31508254 31508256 31508258 31508260 31508262 31508264 31508266 31508268 31508270 31508271 31508273 31508274 31508276 31508277 31508279 31508280</p>
	<p>IRT IZ3 DH W10161- Complete set</p> <p style="text-align: right;">RT1 RT1 RT1 RT1 RT1 RT1 RT1 RT1 RT1 RT1 RT2 RT2 RT6 RT6 RT6 RT6 RT6 RT6 RT6 RT 7 & RT 8 RT 7 & RT 8 RT 7 & RT 8</p>	<p style="text-align: center;">30-1W 34-1W 36-1W 38-1W 42-1W 26-2W 30-2W 34-2W 36-2W / 7236 38-2W 68W 72W 36W 42W 52W / 60W 68W / 72W 76W / 84W IQCIRM - 30 IQCIRM - 34 IQCIRM - 36</p>	<p style="text-align: center;">39208255 39208257 39208258 39208259 39208261 39208263 39208265 39208267 39208268 39208269 39208272 39208273 39208274 39208275 39208276 39208277 39208278 39208281 39208282 39208283</p>	<p style="text-align: center;">31508255 31508257 31508258 31508259 31508261 31508263 31508265 31508267 31508268 31508269 31508272 31508273 31508274 31508275 31508276 31508277 31508278 31508281 31508282 31508283</p>
	<p>ICIR IZ3 W10161- Complete set</p> <p style="text-align: right;">RT27</p>	<p style="text-align: center;">3636</p>	<p style="text-align: center;">39208284</p>	<p style="text-align: center;">31508284</p>

* Specific sizes/shapes need to be ordered by part number through the Marvin ordering system.

ILLUSTRATION NOT TO SCALE	DESCRIPTION	CALL NUMBER	BARE WOOD	WHITE INTERIOR
	<p>Interior Trim W1366</p> <p style="text-align: right;">Lineal</p>	<p style="text-align: center;">96 1/4" (2445) 120" (3048)</p>	<p style="text-align: center;">31760796 31760999</p>	<p style="text-align: center;">39230796 39230999</p>
	<p>Plinth Block <i>NOTE: Pine</i></p> <p style="text-align: right;">Each</p> <p style="text-align: right;">Box of 50</p>		<p style="text-align: center;">11850093 10499100</p>	<p style="text-align: center;">39299100</p>

ILLUSTRATION <i>NOT TO SCALE</i>	DESCRIPTION	PART NUMBER
	<p>Bullet Catch (Grille Fastener)</p>	<p>02062398</p>

When ordering replacement grilles, specify:

1. Description, see Integrity Architectural Detail Manual for Measurement Conversions;
2. Hub OM if available;
3. Quantity;
4. Bare wood or white interior.
5. Grille fasteners on separate order if needed.

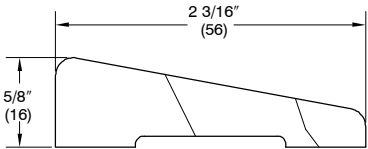
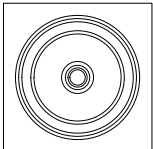
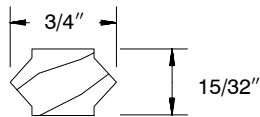

Grille End Profile

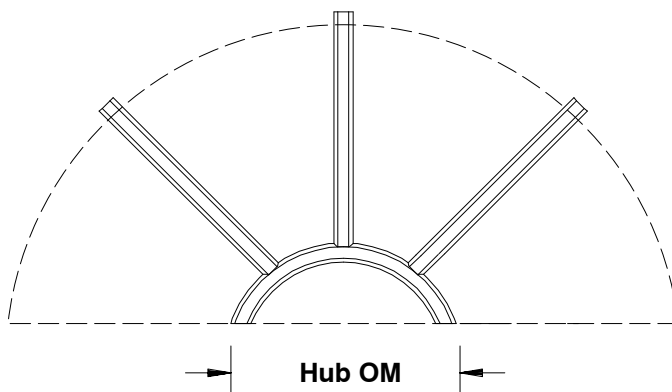
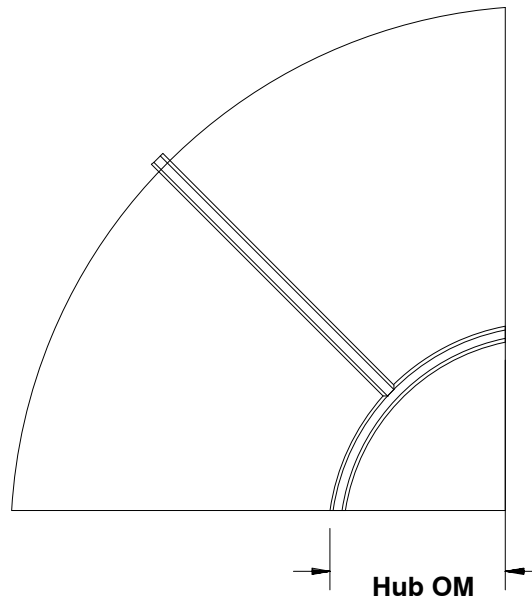

When ordering replacement glass specify:

1. Description;
2. Call number;
3. Glazing;
4. Part number.

IRT IZ3 Replacement Glass Shapes

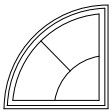

**Casement
Quarter Circle
(RT7 / RT8)**

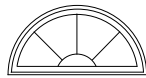

**Casement
True Half (RT1)**

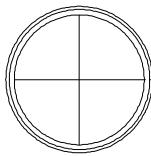

**Double Hung
Full Circle (RT27)**

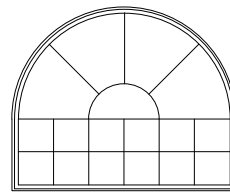

**Casement - True Half above
Springline(RT2)**

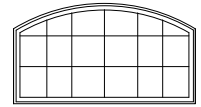

**Casement-Eyebrow
above Springline (RT6)**

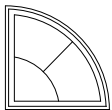

**Double Hung
Quarter Circle
(RT7 / RT8)**

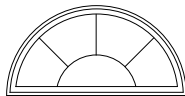

**Double Hung
True Half (RT1)**

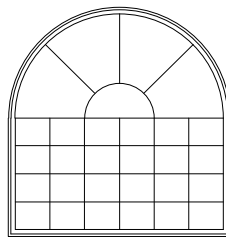

**Double Hung-True Half
above Springline (RT2)**

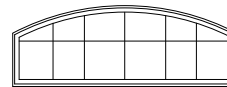

**Double Hung-Eyebrow
above Springline (RT6)**

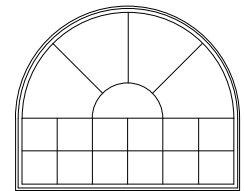

**Door-True Half above
Springline (RT2)**

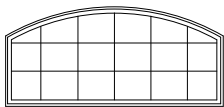

**Door-Eyebrow above
Springline (RT6)**

Available Divided Lite Patterns

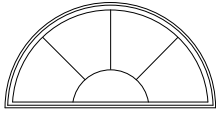

**Open Hub, 3 Spokes
Sunburst Lite Cut
Wood Grilles**

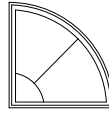

**Open Hub,
1 Spoke
Sunburst Lite Cut
Wood Grilles**

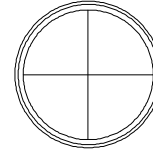

**Rectangular Lite
Cut 2W2H
Wood Grilles**

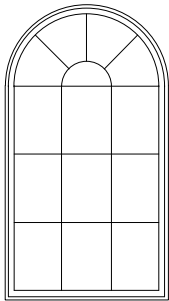

**Open Hub, 3 Spokes Sunburst Lite Cut
Wood Grilles**

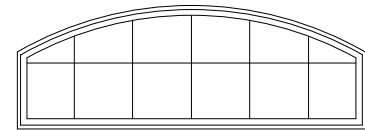
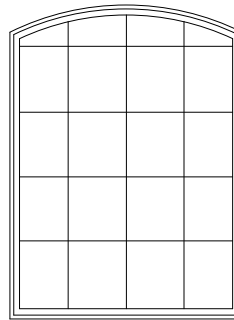
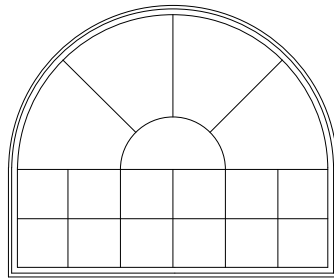

**Rectangular Lite Cut
Wood Grilles**

IRT IZ3 – RT 1 and RT 2: 1-Lite – LoE² 272[®] and LoE³ 366[®]

NOTE: Replacement stops must be ordered when replacing Integrity Round Top glass

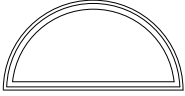
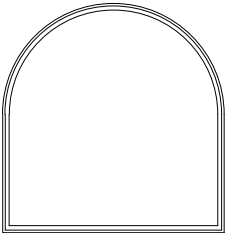
Shape	Call Number	LoE ² 272 One-Lite	LoE ³ 366 One-Lite
	RT 1 – 1 Lite – Casement		
	21–2W CA	12897225	2897225
	25–2W CA	12897235	2897235
	25–3W / 37–2W CA	12897255	2897255
	29–1W CA	12897215	2897215
	29–2W CA	12897245	2897245
	33–1W CA	12898755	2898755
	33–2W CA	12861295	2861295
	37–1W CA	12898665	2898665
	RT 1 – 1 Lite – Double Hung		
	26–2W DH	12847225	2847225
	30–1W DH	12897265	2897265
	30–2W DH	12856265	2856265
	34–1W DH	12897275	2897275
	34–2W DH	12896225	2896225
	36–1W DH	12898715	2898715
	36–2W / 7236 DH	12897325	2897325
	38–1W DH	12896255	2896255
	38–2W DH	12898735	2898735
	42–1W DH	12898695	2898695
	RT 2 – 1 Lite – Casement		
	3765 CA	12833625	2833625
	3777 CA	12833745	2833745
	4971 CA	12845685	2845685
	4983 CA	12845805	2845805
	7359 CA	12869565	2869565
	RT 2 – 1 Lite – Double Hung		
	6869 DH	12898805	2898805
	RT 2 – 1 Lite – Double Hung / Door		
	7259 DH/DR	12898815	2898815

NOTE: Replacement stops must be ordered when replacing Integrity Round Top glass

IRT IZ3 – RT 6: 1-Lite – LoE² 272[®] and LoE³ 366[®]

NOTE: Replacement stops must be ordered when replacing Integrity Round Top glass

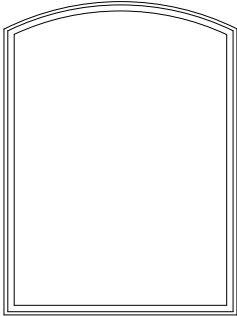
Shape	Call Number	LoE ² 272 One-Lite	LoE ³ 366 One-Lite
	RT 6 – 1 Lite – Casement		
	3722 CA	12833185	2833185
	4921 CA	12898675	2898675
	4965 CA	12845615	2845615
	5724 CA	12898795	2898795
	6523 CA	12861205	2861205
	7325 CA	12698605	2698605
	7369 CA	12869655	2869655
	RT 6 – 1 Lite – Double Hung		
	3622 DH	12832185	2832185
	4222 DH	12838185	2838185
	5222 DH	12848195	2848195
	5266 DH	12848635	2848635
	6025 DH	12856215	2856215
	6069 DH	12856655	2856655
	6824 DH	12898895	2898895
	6868 DH	12898745	2898745
	7626 DH	12872235	2872235
	8429 DH	12880255	2880255
	RT 6 – 1 Lite – Double Hung / Door		
	7225 DH/DR	12898855	2898855
	7233 DH/DR	12898785	2898785
	7269 DH/DR	12865655	2865655

IRT IZ3 – RT 7 / RT 8 and RT27: One lite – LoE² 272[®] and LoE³ 366[®]

NOTE: Replacement stops must be ordered when replacing Integrity Round Top glass

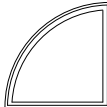
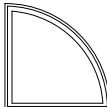
Shape	Call Number	LoE ² 272 One-Lite	LoE ³ 366 One-Lite
 RT 7	RT 7 and RT 8 – 1 Lite – Casement		
	IQCIRM 25 – 1W CA	12898655	2898655
	IQCIRM 29 – 1W CA	12897205	2897205
 RT 8	RT 7 and RT 8 – 1 Lite – Double Hung		
	QCIRM 30 – 1W DH	12826275	2826275
	QCIRM 34 – 1W DH	12833335	2833335
	QCIRM 36 – 1W DH	12833325	2833325

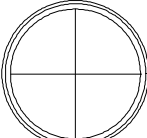
Shape	Call Number	1 –Lite Part Number
	LoE² 272 RT 27	
	ICIRM 3636	12832325
	LoE³ 366 RT 27	
	ICIRM 3636	2832325